

J-Box LED Downlight

CPS Series | Retrofit & New Construction



J-box LED commercial downlight-CPS series are available in 4", 6", 8" and 10" with up to 40w. The innovative separable design of junction box and trim makes it more flexible. Easy-fit installation comes from the adjustable butterfly clips. The downlight is built with an integral junction box that eliminates the need for a traditional recessed housing and mounts directly into ceiling in the new construction which is easy to install. The fixture simply gets wired to a wall switch and placed into the ceiling - no can, bulb or extra labor required! It is designed and engineered for recessed applications, which is suitable for commercial and public places and elegantly decorates the ambience, such as shopping mall, hospital, airport, hotel lobby etc.



Feature

- UL, CUL, Energy Star and Damp Rated
- 40W maximum with 4", 6", 8" and 10" trim size options
- Available in round, square, round wall wash and square wall wash trims
- Twist-lock modular design
- Integrated J-box for direct wire, eliminated recessed can
- CCT adjustable and wattage selectable
- New construction frame kit available



PERFORMANCE

Item	Lumen Output			Type
	High	Medium	Low	
Maximum 20W	20w, 75lm/w	15w, 78lm/w	10w, 80lm/w	IC
Maximum 40W	40w, 80lm/w	34w, 85lm/w	27w, 90lm/w	NON-IC

Remark: Maximum 20W with 4", 6", 8" trims and maximum 40w with 4", 6", 8", 10" trims are listed on Energy Star. All efficacy is ±5% base on different CCT and Trims. Check the IES file to gain the accurate data.



J-Box LED Downlight

CPS Series | Retrofit & New Construction



STRUCTURE

► Structure

Spun aluminum reflector integrated with haze finish and white trim ring with shadow free.

► Trim Options

- Round Trim: 4", 6", 8", 10"
- Square Trim: 4", 6"
- Round Wall Wash Trim: 4", 6"
- Square Wall Wash Trim: 4", 6"

► Electrical

LED Driver	It is powered by Class 2 high efficiency LED driver, with a standard 1-10V dimming which continuous dims to 10% that works with many types of controls. Tested Dimmers: Lutron ® Diva-Dvtv, Leviton ® IP-710-DL.
THD	<20%
Power Factor	>0.9
Input Voltage	Standard electronic drivers are cULus recognized and available for 120-347V AC or 120-277V*.

► LED System

CRI	Minimum 80 color rendering index
CCT	CCT adjustable from 3000K,3500K and 4000K with a great color consistency.
Thermal Management	Aluminum housing acting as the heat sink to maximize life.

► Mounting

Recessed
Durable tension clips are allowing for fast and easy installation

► Approvals

- cULus listed for damp locations
- Energy Star Listed
- Tested to IESNA LM-79 and LM-80
- 5 years limited warranty

► Optional Function

Emergency Option
Optional high voltage 8W emergency LED driver EM-H08170-LBF can be provided. When AC power fails, it immediately switches to the emergency mode, operating for lighting up to 120 minutes. When AC power is restored, it automatically returns to the charging mode which meets critical life-safety lighting requirements.
For more info or spec sheet, please visit our website or contact sales.



Emergency Lumen Output:

Fixture Efficacy	Output Power 8w
80lm/w	640 Lumens

PRODUCT ORDERING GUIDE

Sample

CP 6 - D 15W - 40T
1 2 3 4 5

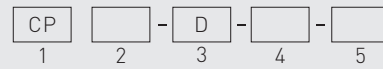

1. Base Model

CP

2. Aperture

- 4 4"
 6 6"
 8 8" (Only for round trim)
 10 10" (Only for round trim)

3. Dimming

D 1-10V Dimming

4. Wattage

- 20W-35W Wattage Selectable (20W, 15W, 10W)
CCT Adjustable (3000K,3500K,4000K)
 40W-35T Wattage Selectable (40W, 34W, 27W)
CCT Adjustable (3000K,3500K,4000K)
 10W-40T CCT Adjustable (3000K,4000K,5000K) *
 15W-40T CCT Adjustable (3000K,4000K,5000K) *
 20W-50E Wattage Selectable (20W,15W,10W)
CCT Adjustable (3000K,4000K,5000K)

OPTIONAL ORDERING GUIDE

Trim Shape

- Round Trim
 Square Trim
 Round Wall Wash Trim
 Square Wall Wash Trim

Optional Mounting Kit

- 4"-8" New Construction Frame Kit
 10" New Construction Frame Kit *

Optional Functions

- LED Emergency Driver (Order Separated)

*Additional cost and/or lead time on customized fixtures may apply. Some fixtures require an MOQ. Please contact your sales rep for more information.

J-Box LED Downlight

CPS Series | Retrofit & New Construction



TRIM DIMENSIONS

Round Trims

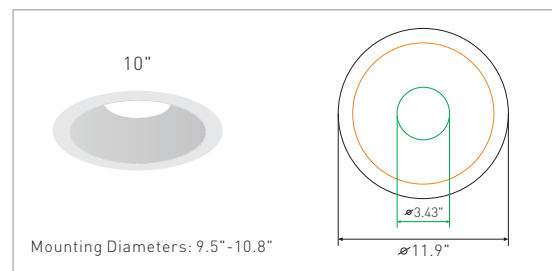
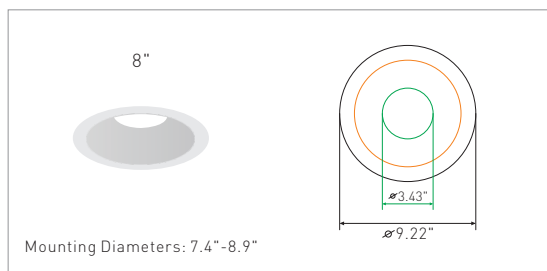
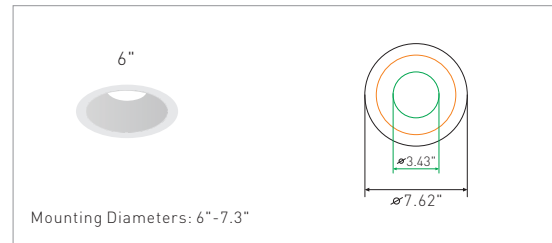
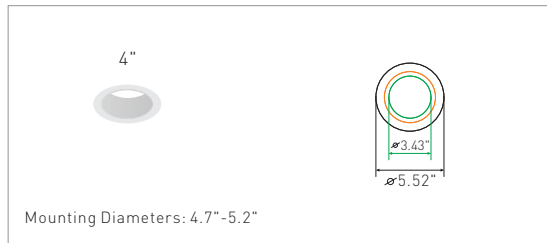

Round Wall Wash Trims

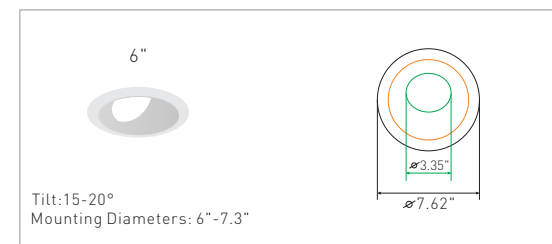

Square Trims

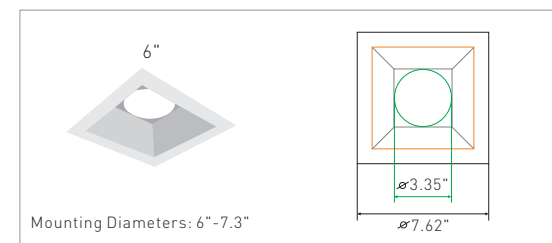
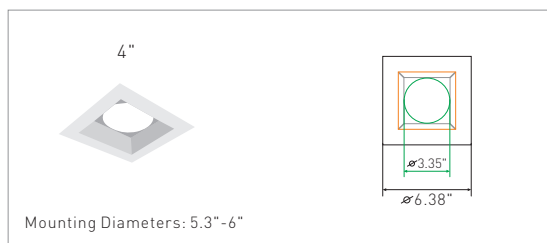

Square Wall Wash Trims

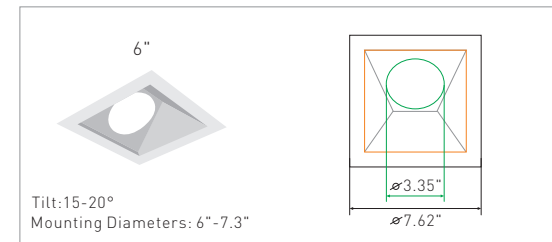
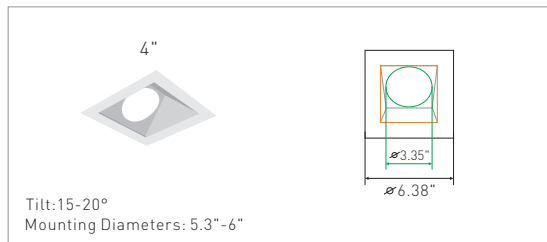

J-Box LED Downlight

CPS Series | Retrofit & New Construction



ENGINE

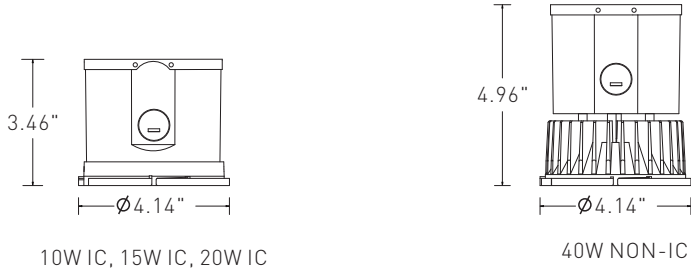

OPTIONAL NEW CONSTRUCTION FRAME KITS

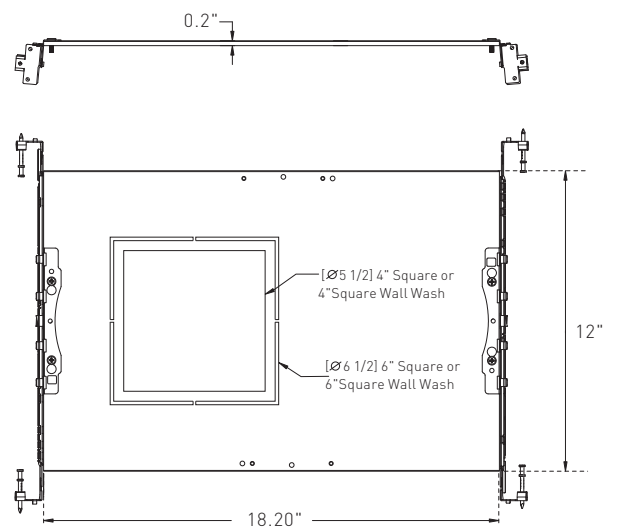
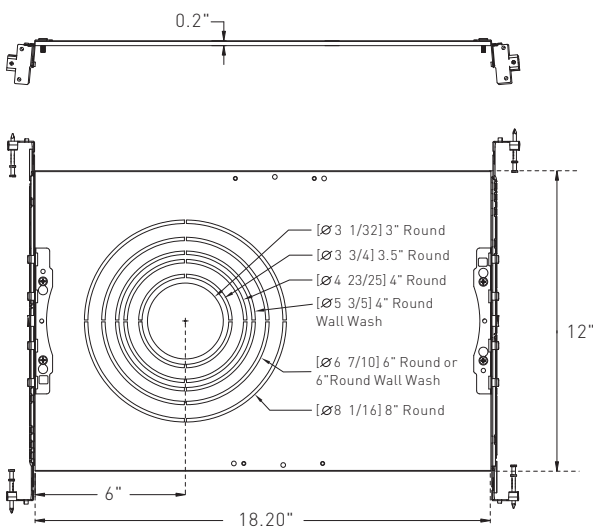
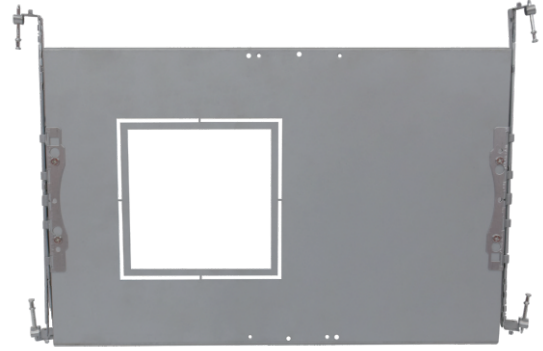

J-Box LED Downlight

CPS Series | Retrofit & New Construction



DISTRIBUTION DIAGRAM

6" 40W Round Trim

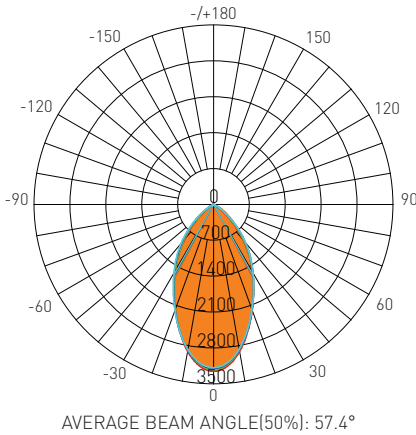

Test Number: CP6-D40W-40T
 Lumens: 3328.0 Lm
 Watts: 40 W
 LPW: 83.2 Lm/W
 CCT: 4000K

UNIT: cd
 C0/180,56.4°
 C30/210,56.9°
 C60/240,57.9°
 C90/270,58.4°

Zonal Flux Diagram					
T	C0	C45	C90	C135	C180
10	2916	2896	2871	2857	2912
20	2201	2209	2188	2161	2186
30	1521	1544	1542	1506	1498
40	891.0	956.2	972.7	929.2	869.3
50	335.4	424.5	441.2	395.6	321.0
60	58.83	91.82	97.54	78.63	54.01
70	3.285	2.050	1.504	1.915	3.235
80	1.606	0.8562	0.5011	0.8066	1.591
90	0.1094	0.0676	0.0949	0.0811	0.0721
100	0.0902	0.0812	0.0857	0.0992	0.0993
110	0.1532	0.2302	0.2280	0.2212	0.1986
120	0.5046	0.6317	0.6711	0.6273	0.5778
130	1.262	1.372	1.496	1.403	1.359
140	2.366	2.405	2.542	2.450	2.455
150	3.683	3.717	3.809	3.735	3.735
160	5.157	5.110	5.117	5.088	5.184
170	6.245	6.183	6.145	6.160	6.273
180	6.732	6.710	6.593	6.620	6.755
DEG	LUMINOUS INTENSITY:cd				

Zonal Lumens	
T	φ total
0-10	289.3
10-20	997.9
20-30	1840
30-40	2601
40-50	3101
50-60	3290
60-70	3317
70-80	3318
80-90	3319
90-100	3319
100-110	3319
110-120	3320
120-130	3320
130-140	3322
140-150	3324
150-160	3326
160-170	3327
170-180	3328
DEG	UNIT: lm

Luminance cd/(m2)		
G(DEG)	C0/180	C90/270
85	742	162
80	524	163
75	497	189
70	544	249
65	1661	3557
60	6661	11045
55	15820	22953
50	29545	38863
45	47042	55891

6" 40W Round Wall Wash

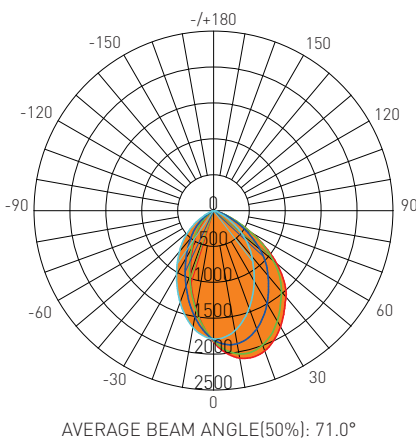

Test Number: CP6-D40W-30W-C
 Lumens: 2949.1 Lm
 Watts: 40 W
 LPW: 73.73 Lm/W
 CCT: 3000K

UNIT: cd
 C0/180,69.2°
 C30/210,70.4°
 C60/240,72.4°
 C90/270,72.2°

Zonal Flux Diagram					
T	C0	C45	C90	C135	C180
10	2085	1962	1700	1461	1397
20	2080	1892	1449	1069	944.4
30	1866	1658	1132	716.4	584.0
40	1572	1343	828.3	446.7	318.6
50	1152	1001	540.1	222.7	107.6
60	593.4	562.8	253.7	36.59	12.99
70	169.5	186.5	59.76	4.875	5.799
80	4.680	16.81	1.576	1.973	2.586
90	0.0996	0.0631	0.0831	0.1709	0.1311
100	0.0811	0.0677	0.1123	0.2708	0.3476
110	0.0812	0.1309	0.3018	0.6949	0.9297
120	0.2162	0.3294	0.7163	1.394	1.832
130	0.4958	0.6814	1.271	2.125	2.851
140	0.9914	1.173	1.857	2.832	3.771
150	1.650	1.822	2.520	3.504	4.325
160	2.502	2.603	3.201	3.991	4.613
170	3.422	3.432	3.765	4.225	4.744
180	4.216	4.104	4.000	4.054	4.230
DEG	LUMINOUS INTENSITY:cd				

Zonal Lumens	
T	φ total
0-10	166.4
10-20	610.3
20-30	1207
30-40	1830
40-50	2383
50-60	2750
60-70	2907
70-80	2940
80-90	2941
90-100	2941
100-110	2942
110-120	2942
120-130	2943
130-140	2945
140-150	2946
150-160	2948
160-170	2949
170-180	2949
DEG	UNIT: lm

Luminance cd/(m2)		
G(DEG)	C0/180	C90/270
85	182	531
80	1526	514
75	14095	3272
70	28056	9893
65	45639	18782
60	67192	28730
55	86754	38552
50	101454	47569
45	111057	55165

J-Box LED Downlight

CPS Series | Retrofit & New Construction



DISTRIBUTION DIAGRAM

6" 20W Square Trim

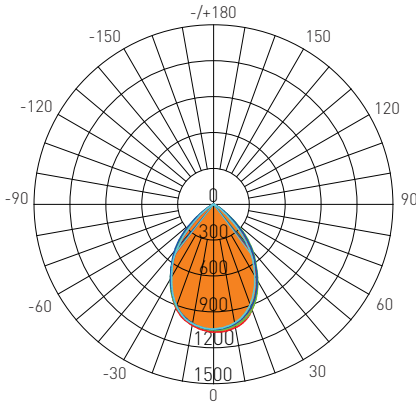

Test Number: CP6-D20W-40E-S UNIT: cd
 Lumens: 1515.4 Lm C0/180,75.1 °
 Watts: 20 W C30/210,77.8 °
 LPW: 75.77 Lm/W C60/240,78.3 °
 CCT: 4000K C90/270,75.1 °

Zonal Flux Diagram

T	C0	C45	C90	C135	C180
10	1047	1022	1007	992.7	1027
20	939.2	932.1	893.4	892.4	922.1
30	719.9	739.1	687.3	709.4	711.5
40	471.7	497.7	440.1	477.0	457.8
50	170.8	280.1	158.0	250.7	159.6
60	32.27	62.15	30.20	46.44	33.23
70	2.699	4.711	3.380	4.018	3.231
80	1.543	2.277	2.065	2.620	1.965
90	0.1002	0.0711	0.1300	0.0681	0.1300
100	0.0406	0.0496	0.0406	0.0406	0.0451
110	0.0587	0.1195	0.1128	0.1015	0.1038
120	0.2476	0.3584	0.3114	0.3492	0.3024
130	0.6308	0.7486	0.6814	0.7350	0.7086
140	1.149	1.193	1.150	1.217	1.205
150	1.614	1.648	1.633	1.653	1.682
160	2.155	2.061	2.043	2.088	2.156
170	2.363	2.331	2.304	2.322	2.422
180	2.498	2.444	2.431	2.415	2.503
DEG	LUMINOUS INTENSITY:cd				

Zonal Lumens

T	φ total
0-10	98.17
10-20	371.6
20-30	748.1
30-40	1122
40-50	1389
50-60	1490
60-70	1507
70-80	1510
80-90	1511
90-100	1511
100-110	1511
110-120	1512
120-130	1512
130-140	1513
140-150	1514
150-160	1515
160-170	1515
170-180	1515
DEG	UNIT: lm

Luminance cd/(m2)

G(DEG)	C0/180	C90/270
85	662	908
80	395	528
75	341	445
70	351	439
65	965	913
60	2869	2684
55	6050	5712
50	11807	10926
45	19770	18214

6" 20W Square Wall Wash

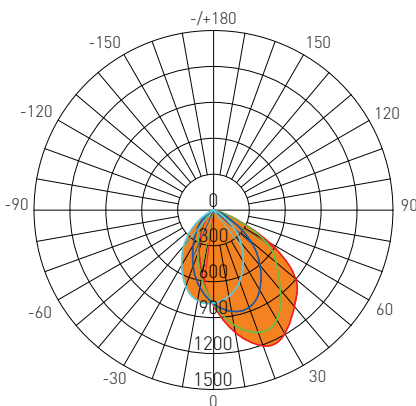

Test Number: CP6-D20W-40W-S UNIT: cd
 Lumens: 1590.6 Lm C0/180,65.4 °
 Watts: 20 W C30/210,68.8 °
 LPW: 79.53 Lm/W C60/240,72.5 °
 CCT: 4000K C90/270,77.0 °

Zonal Flux Diagram

T	C0	C45	C90	C135	C180
10	1038	919.6	732.9	585.3	554.5
20	1209	984.8	638.0	411.7	353.7
30	1192	930.7	494.7	267.4	210.7
40	1053	743.2	354.7	155.9	97.27
50	896.8	548.9	205.7	66.71	21.28
60	526.2	310.4	73.90	12.46	5.292
70	136.0	73.16	14.65	4.282	4.094
80	12.17	4.784	1.600	3.400	3.395
90	0.1674	0.0925	0.0768	0.1779	0.0947
100	0.0812	0.0812	0.1175	0.2143	0.3070
110	0.0631	0.0925	0.1760	0.5996	0.7989
120	1.081	0.1646	0.3880	1.220	1.633
130	0.1577	0.2909	0.6721	1.526	2.147
140	0.3513	0.4938	0.9789	1.914	2.359
150	0.6173	0.7667	1.276	2.081	2.534
160	0.9781	1.127	1.565	2.182	2.530
170	1.433	1.522	1.781	2.153	2.340
180	1.935	1.851	1.826	1.847	1.944
DEG	LUMINOUS INTENSITY:cd				

Zonal Lumens

T	φ total
0-10	73.89
10-20	284.3
20-30	592.3
30-40	929.2
40-50	1235
50-60	1461
60-70	1563
70-80	1584
80-90	1586
90-100	1586
100-110	1586
110-120	1587
120-130	1588
130-140	1588
140-150	1589
150-160	1590
160-170	1590
170-180	1591
DEG	UNIT: lm

Luminance cd/(m2)

G(DEG)	C0/180	C90/270
85	373	694
80	3114	410
75	9473	779
70	17677	1904
65	31770	3741
60	46776	6569
55	57281	10368
50	62005	14225
45	61916	17780